

# NEPEL TYP1

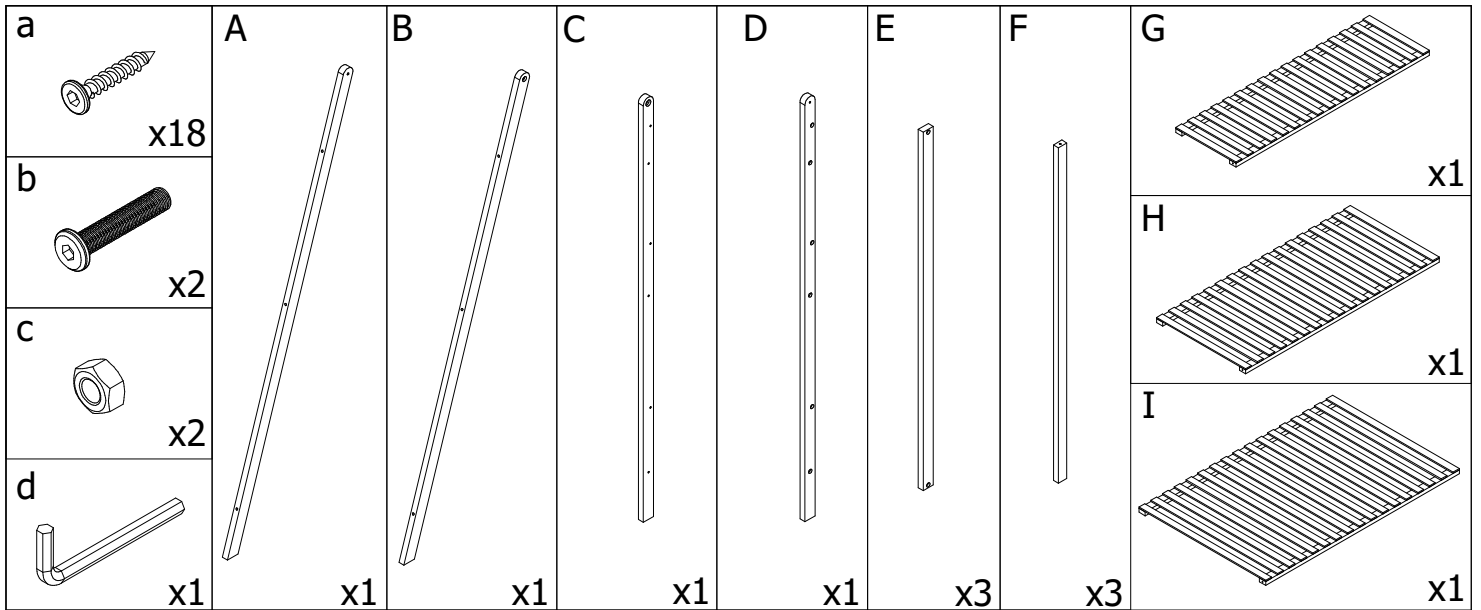

1

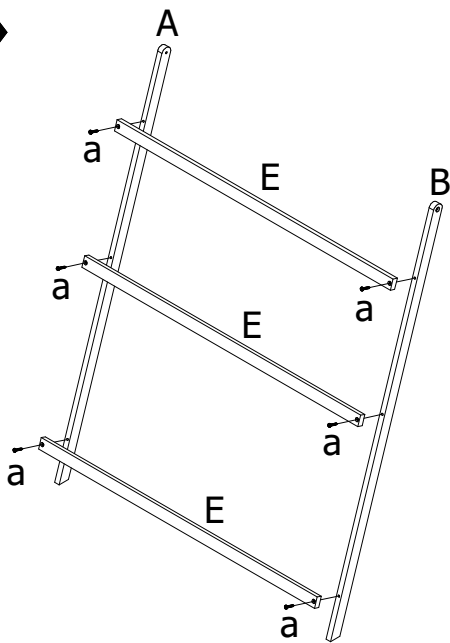

2

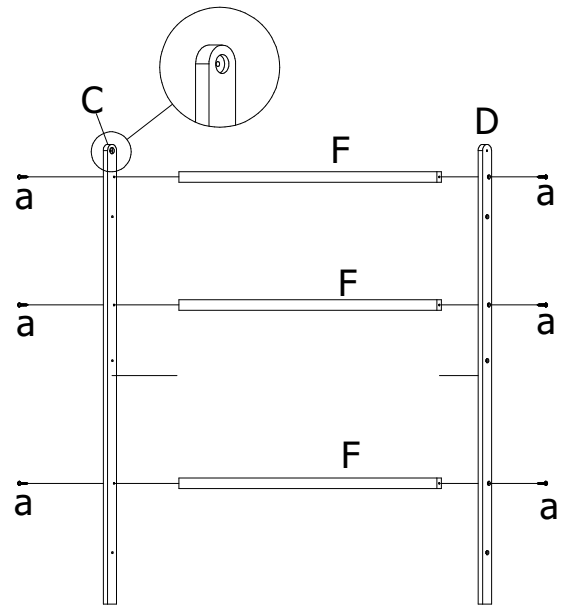

3

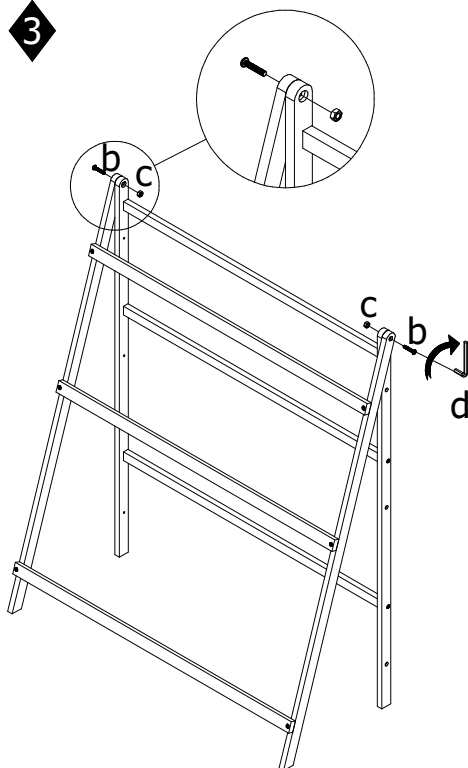

4

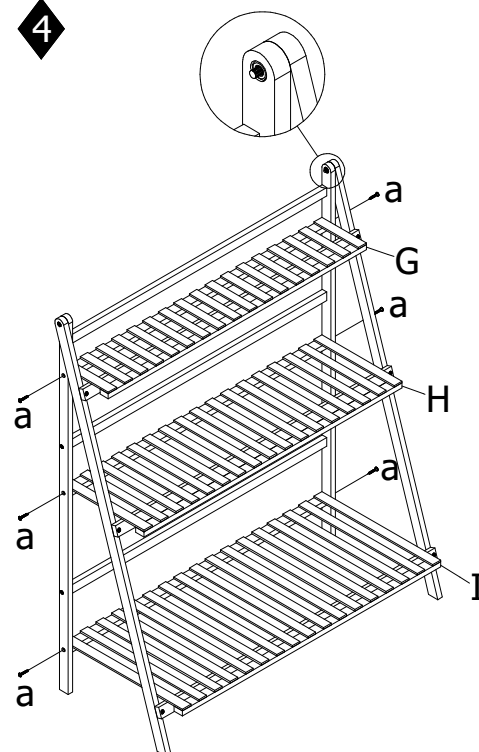

5

